

PLAN

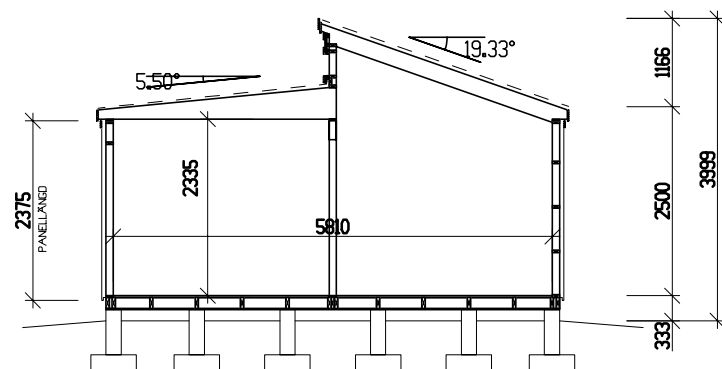

SEKTION

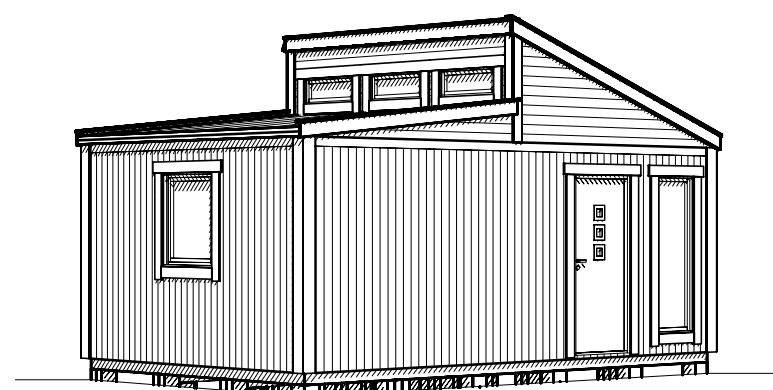

PERSPEKTIV

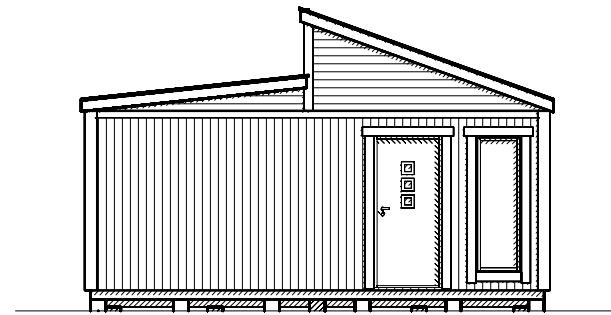

FASAD MOT

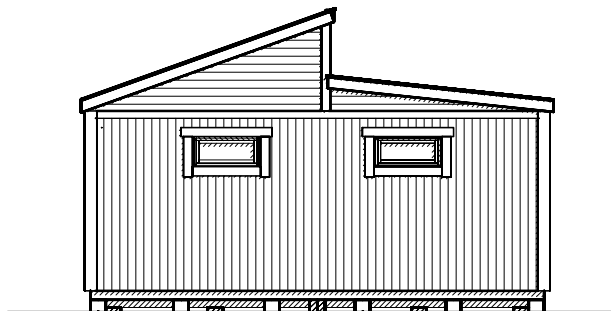

FASAD MOT

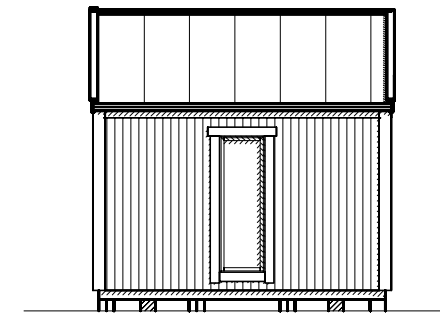
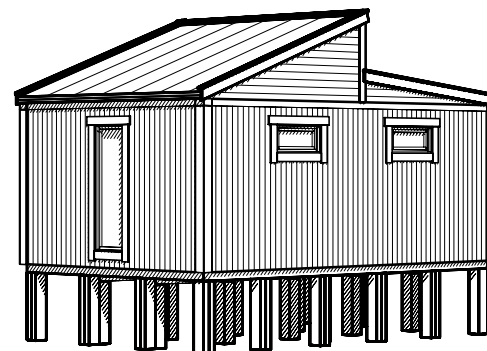

FASAD MOT

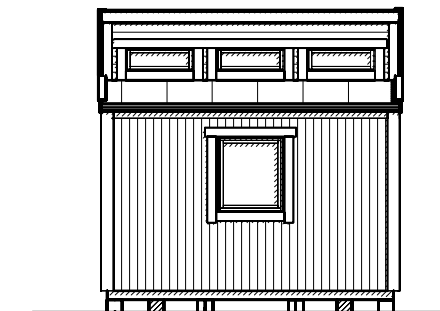

FASAD MOT

PANEL: FUNKISPANEL 22x120.
 STOMME: 34x95.
 OISLERAT.
 BJÄKLÄG 45x145.
 GRUNDLÄGGNING: PLINT GRUND.
 LEVERANSOMFATTNING ENLIGT AVTAL.

BET	ANT	ÄNDRINGEN AVSER	DATUM	SIGN
-----	-----	-----------------	-------	------

FÖRSLAGSRITNING

NYBYGGNAD AV KOMPLEMENTBYGGNAD
 TRIVAS 25



UPPDRAG NR/RITN. NR RITAD/KONSTR AV

XXXX

PH

DATUM

2015-10-13

HANDLÄGGARE

ANSVARIG

PLAN & SEKTION
 TRIVAS 25

TYP AMBJÖRNARP – MODUL EXEMPEL

SKALA

1:100, A3

NUMMER

A01

BET