

PLAN

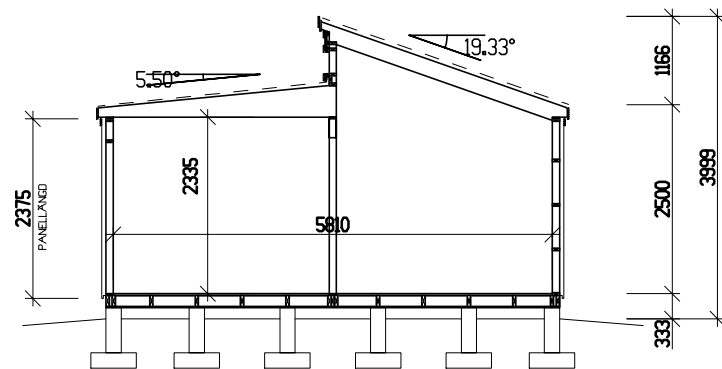

SEKTION

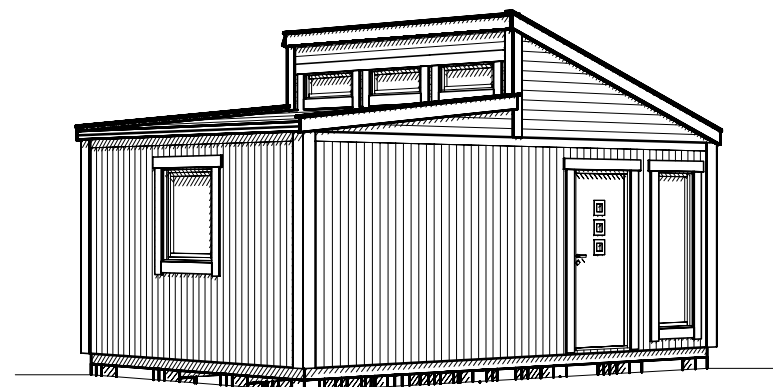

PERSPEKTIV

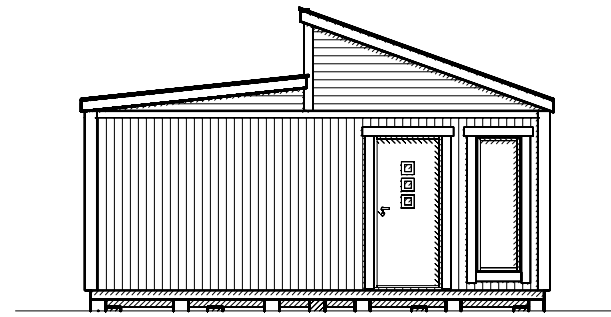

FASAD MOT

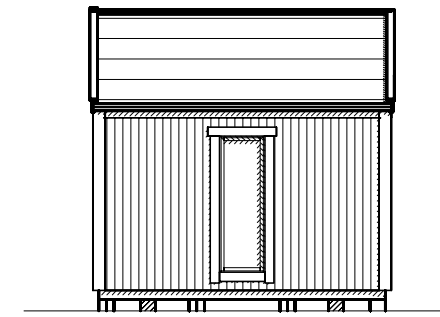

FASAD MOT

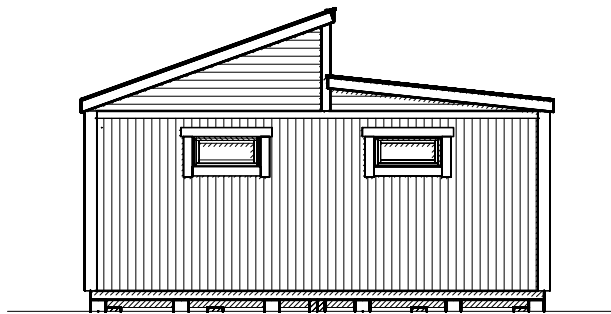

FASAD MOT

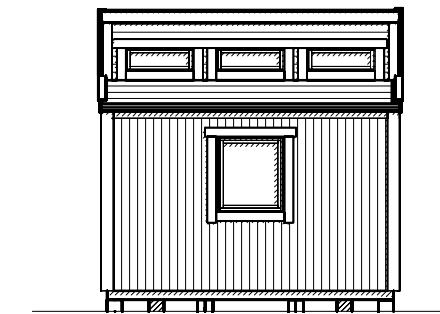

FASAD MOT

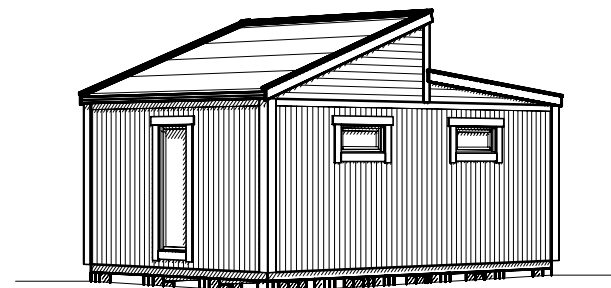

PANEL: FUNKISPANEL 22x120.
 STOMME: 34x95.
 OISLERAT.
 BJÄLKLAG 45x145.
 GRUNDLÄGGNING: PLINT GRUND.
 LEVERANSOMFATTNING ENLIGT AVTAL.

BET	ANT	ÄNDRINGEN AVSER	DATUM	SIGN
-----	-----	-----------------	-------	------

FÖRSLAGSRITNING
 NYBYGGNAD AV KOMPLEMENTBYGGNAD



UPPDRAG NR/RITN. NR XXXX	RITAD/KONSTR AV PH
DATUM 2018-10-16	HANDLÄGGARE

PLAN & SEKTION
 TRIVAS 25-1

ANSVARIG	SKALA 1:100, A3	NUMMER A01	BET
----------	--------------------	---------------	-----